



PORTFOLIO

**CAPSULES**



**TABLETS**



**SOFTGELS**



**BOTTLES**



**YOUR BRAND**



**LIQUIDS**



**POWDER**



**BLISTERS**



**GUMMIES**





# CAPSULES



### 1 Capsules

- Vegetarian (Vegan)
- Gelatine
- Delayed release
- Without Titanium Dioxide

This capsule holds **290 to 575 mg** of powder.\*

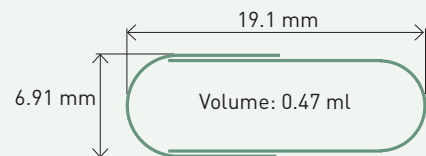

### 0 Capsules

- Vegetarian (Vegan)
- Gelatine
- Delayed release
- Without Titanium Dioxide

This capsule holds **400 to 805 mg** of powder.\*

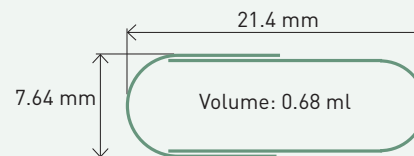

### 00 Capsules

- Vegetarian (Vegan)
- Gelatine
- Delayed release
- Without Titanium Dioxide

This capsule holds **500 to 1140 mg** of powder.\*

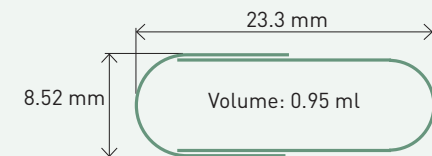



# TABLETS



**16 x 8 mm**  
**Oval-shaped**  
flat

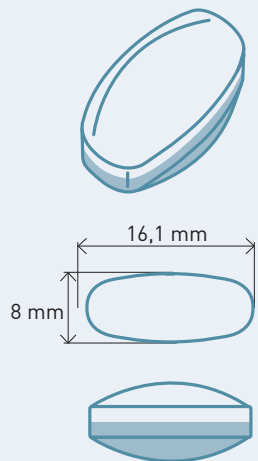

**19,1 x 8.5 mm**  
**Oval-shaped**  
flat

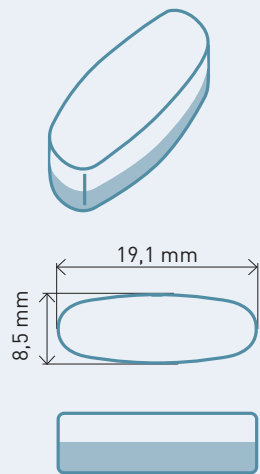

**22.4 x 8.5 mm**  
**Oval-shaped**  
flat

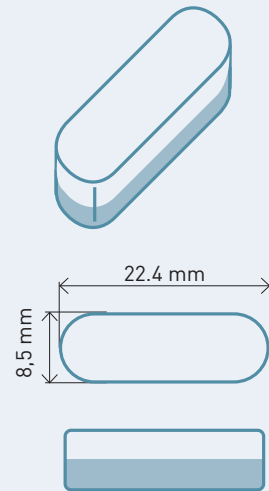

**Ø 7 mm**  
**Round**  
Tablet

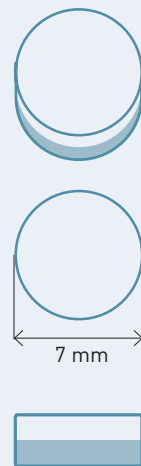

**Ø 10 mm**  
**Round**  
Tablet



**Ø 10.5 mm**  
**Round**  
Tablet



**Ø 20 mm**  
**Round**  
Tablet  
(With cross)



**Ø 25 mm**  
**Round**  
Tablet

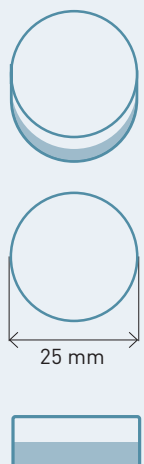

All tablet formats can also be made in BILAYER.



# SOFTGELS

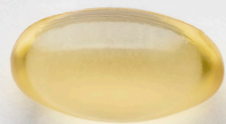

**VEGETABLE shell  
4 Round**

- Tapioca



Aprox. 200 mg

**VEGETABLE shell  
10 Oval**

- Tapioca



Aprox. 500 mg

**ANIMAL shell  
Oval 3**

- Bovine
- Fish



Aprox. 180 mg

**ANIMAL shell  
Oval 6**

- Bovine
- Fish



Aprox. 320 mg

**ANIMAL shell  
Oval 10**

- Bovine
- Fish



Aprox. 500 mg

Ask us  
for  
**bespoke  
formats.**



**ANIMAL shell  
Oval 12**

- Bovine
- Fish



Aprox. 660 mg



**ANIMAL shell  
Oblong 20**

- Bovine
- Fish



Aprox. 1000 mg



**ANIMAL shell  
Oblong 22**

- Bovine
- Fish



Aprox. 1200 mg



**ANIMAL shell  
Oblong 24**

- Bovine
- Fish



Aprox. 1300 mg

Available in  
different colours,  
coatings and  
finishings.



# BOTTLES



75 to  
500 cc  
PET and  
HDPE  
bottles.

PET



Glass



Biodegradable



With screw cap  
and **induction seal.**

Bottles  
and caps are  
available in  
different  
**colours.**

**Biodegradable  
packaging line.**



# BLISTERS



## Capsules 0/00

10 units.

### Format 0:

73x97x8.2 mm

### Format 00:

73x97x9.3 mm

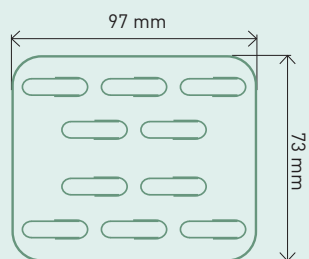

## Capsules 0/00

15 units.

### Format 0:

73x97x8.2 mm

### Format 00:

73x97x9.3 mm

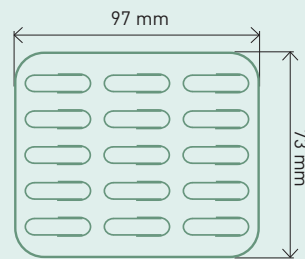

## Softgels

15 units.

### Format Oval 10:

73x97x9.3 mm

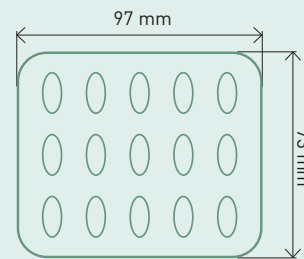

We can  
produce  
**15 unit  
blister in  
Tablets**



## Capsules 0/00

30 units.

**Format 0:** 150x97x8.2 mm

**Format 00:** 150x97x9.3 mm

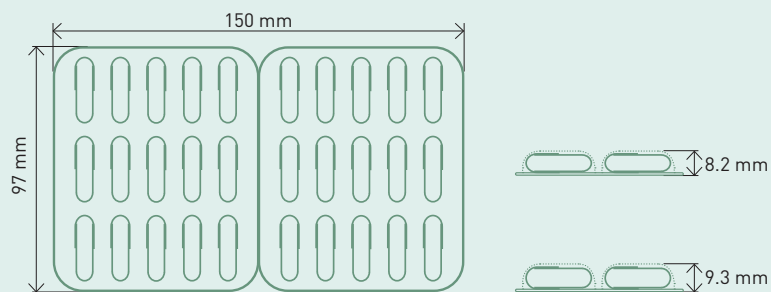

## Capsules 0/00

20 units.

**Format 0:** 150x97x8.2 mm

**Format 00:** 150 x97x9.3 mm

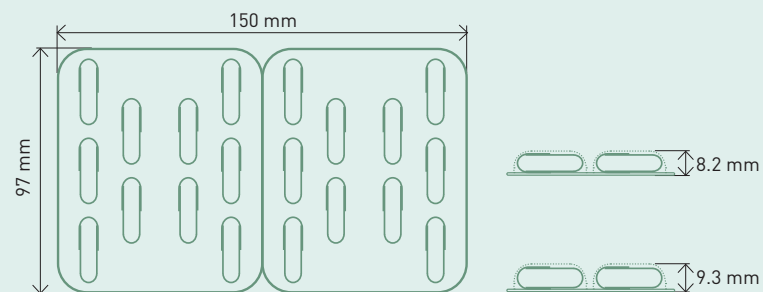

**Multiproduct!**

We can pack **combinations** of capsules, **softgels** and **tablets** in the same blister-pack.



**Tablets 22.4 x 8.5 mm**  
15 units.

**Format Oval-shaped**  
flat: 73x97x6.5 mm

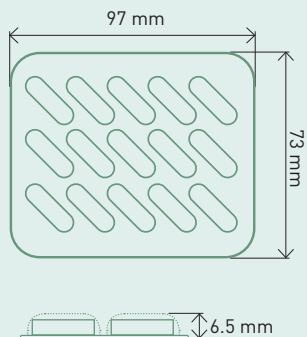

**Tablets 19.1 x 8.5 mm**  
15 units.

**Format Oval-shaped**  
flat: 73x97x6.5 mm

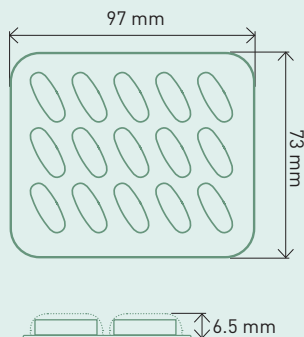

**Tablets Ø 10.5 mm**  
15 units.

**Format Round:**  
73x97x6 mm

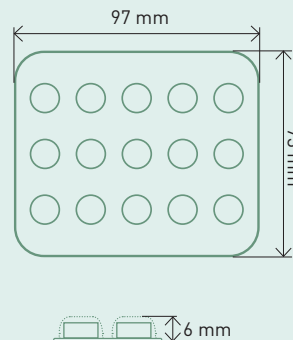

**Tablets Ø 7 mm**  
30 units.

**Format Round:**  
73x97x3.5-5.5 mm

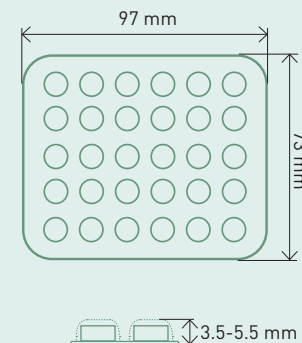

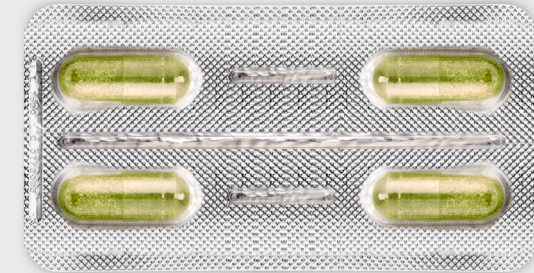
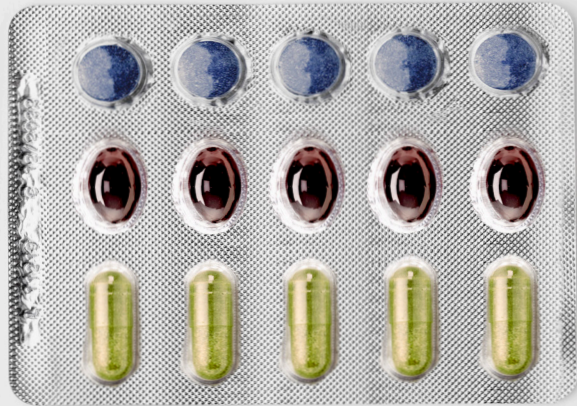

Possibility  
to **combine  
different  
formats** in  
one unique  
blister-pack.

We can pack  
**combinations** of capsules,  
**softgels** and **tablets** in the  
same blister-pack.

## NEW SAMPLE FORMATS

### Capsules 0/00

4 units.

**Size:** 86x43x8.9 mm

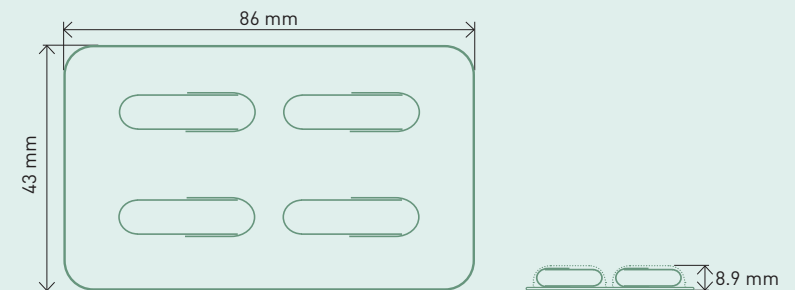



# LIQUIDS



**Vials**  
30 ml white and  
green **PET** vials.



**Vials**  
25 ml amber  
skinny **PET**  
vials.



**Vials**  
10 ml amber  
**PET** vials.



**Sticks**  
Custom  
screen printing  
in a **variety of**  
**lengths.**



Bottles  
available  
from **50ml**  
to **1L**, also  
transparent.

**Syrups**  
125 ml amber  
**PET** bottles.

**Syrups**  
150 ml amber  
**PET** bottles.

**Syrups**  
200 ml amber  
**PET** bottles.

Ask us for more  
formats.



# POWDER



### Simple sachets

in three sizes:

**50x70 mm.**

Capacity between **3-6 g.**

**70x90 mm.**

Capacity between **6-12 g.**

**90x120 mm.**

Capacity between **10-20 g.**

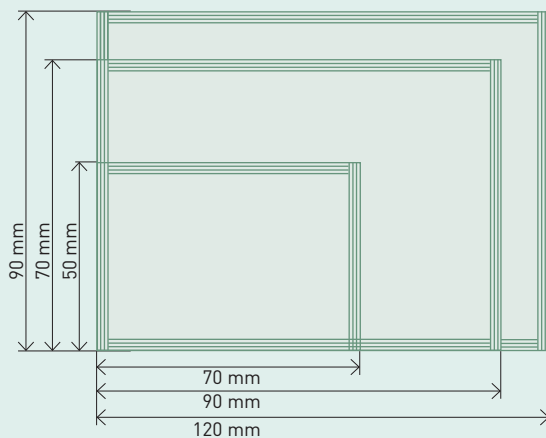

### Double sachets

in two sizes:

**100x70 mm.**

Capacity between **3-6 g.**

**140x90 mm.**

Capacity between **6-12 g.**

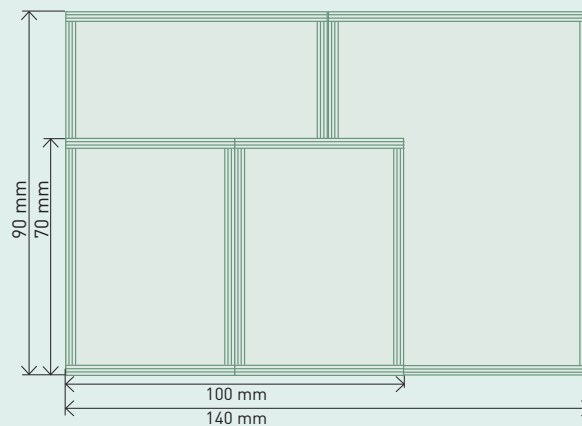

### Containers

Metallic containers for powdered food products.

Also available in **cardboard**, **PET** and **HDPE**.



All sachets have **aluminum** and are **heat-sealed**.

All sachets have **aluminum** and are **heat-sealed**.



# YOUR BRAND

# GUMMIES

FOOD SUPPLEMENTS'  
EVOLUTION TO  
GUMMIES

*Sweeteners free  
Sugar free*



*100%  
Vegetarian*





Calm

Energy

ACV+Ginger

Beauty

HSN

M3 Kids

C+Zn+D

Probiotic

M3 Adults

Sleep

**ENERGY**

Contributes to the daily energy supply.  
**FLAVOUR:** Coca cola

**M3 ADULTS**

Provides the body with vitamins and minerals.  
**FLAVOUR:** Strawberry.

**C+Zn+D**

Improves and strengthens your defences.  
**FLAVOUR:** Orange.

**PROBIOTIC**

Contributes to immune system's normal functioning, and mucous membranes' maintenance.  
**FLAVOUR:** Pineapple.

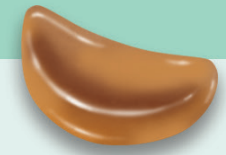
**SLEEP**

Helps to fall asleep and improve sleep.  
**FLAVOUR:** Strawberry.

**HSN**

Vitamins for hair, skin and nails.  
**FLAVOUR:** Fruits of the forest.

**M3 KIDS**

Provides children with vitamins and minerals.  
**FLAVOUR:** Strawberry.

**BEAUTY**

Improves the quality and appearance of your skin.  
**FLAVOUR:** Lime.

**ACV+GINGER**

Contributes to normal blood glucose levels' maintenance and normal thyroid function.  
**FLAVOUR:** Apple.

**CALM**

Helps to improve the quality of sleep.  
**FLAVOUR:** Blackberry.

# MINIMUM ORDER QUANTITY



Capsules	300,000 units
Tablets	300,000 units
Softgels	300,000 units
Syrups	5,000 units
Vials	30,000 units
Sachets	60,000 units
Containers	3,000 units
Gummies	5,000 units (60 Gummies)
Sticks	60,000 units
Doypack	5,000 units



## Sticks

Two widths available: 25mm or 40mm.



## DoyPacks

Only solid formats, no liquids.



CAPSULES



TABLETS



SOFTGELS



NATURE PHARMA  
Rioja